

MECHANICAL

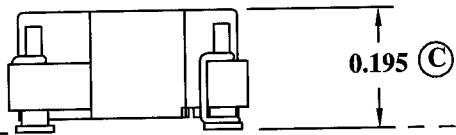

SEATING PLANE

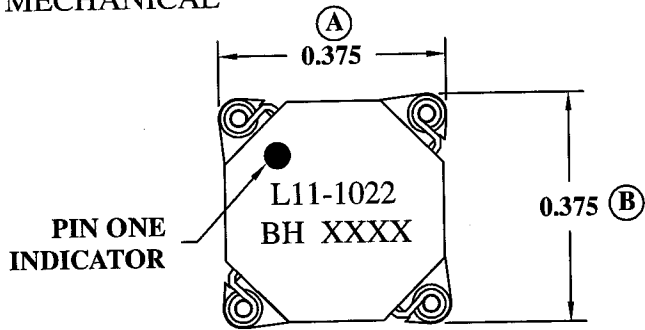
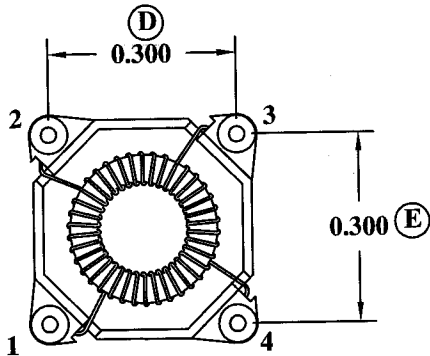

RECOMMENDED PC BOARD LAYOUT

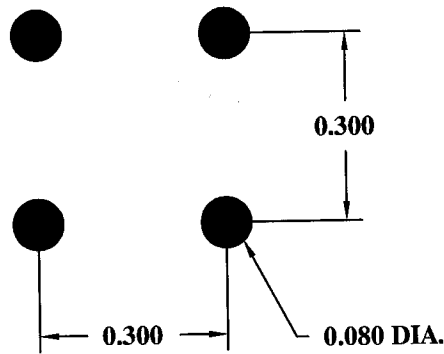

SCHEMATIC

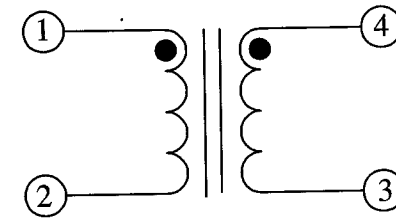

ELECTRICAL SPECIFICATIONS

OPEN CIRCUIT INDUCTANCE: 55.80 μ H \pm 20% @ 0 ADC (1-2)
44.65 μ H TYP. @ 0.81 ADC (1-2)

10 KHz 100mV

DC RESISTANCE: 0.434 OHMS NOM. (1-2) (3-4)

IR: 1K MEGOHMS MIN. @ 100 VDC (1-4)

RoHS Compliant

DESIGN PER:

CATALOG

CUSTOM

NON-PROPRIETARY

X

DRAWN: K. LOFTUS

ENGR: J. DECRAMER

UNLESS OTHERWISE SPECIFIED:
DIMENSIONS IN INCHES, TOLERANCES
NON-CUMULATIVE
.XX \pm .01 .XXX \pm .005

PAGE 1 OF 2



BH ELECTRONICS, INC.
BURNSVILLE & MARSHALL, MN

© 1998 BH Electronics

TITLE:

INDUCTOR

PART NO.

L11-1022

ISSUE	DATE	REVISION	BY
A	8-23-05	CUSTOMER PRINT	<i>[Signature]</i>

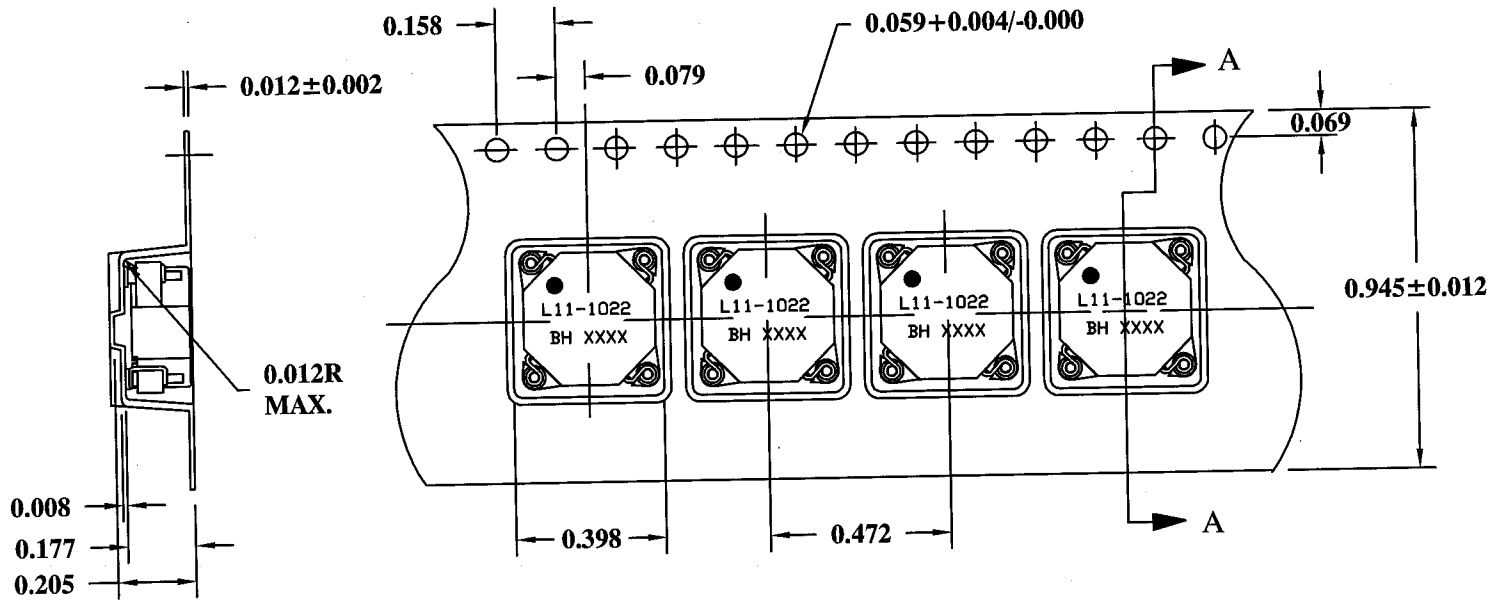

CARRIER TAPE 811-0187

				DESIGN PER:		 BH ELECTRONICS, INC. BURNSVILLE & MARSHALL, MN © 1998 BH Electronics
				CATALOG		
				<input type="checkbox"/> CUSTOM	<input checked="" type="checkbox"/> NON-PROPRIETARY	
				DRAWN:	K. LOFTUS	
				ENGR:	J. DECRAMER	TITLE:
				UNLESS OTHERWISE SPECIFIED: DIMENSIONS IN INCHES, TOLERANCES NON-CUMULATIVE .XX±.01 .XXX±.005		INDUCTOR
A	8-23-05	CUSTOMER PRINT		PAGE 2 OF 2		PART NO.
ISSUE	DATE	REVISION	BY			L11-1022